

Electrolux Professional
Commercial Laundry

‘ Time is money.
That’s why I changed
to Electrolux.’



Eva Roos, Laundry Manager



Thinking of you
Electrolux

Minimise costs and maximise uptime

with the laundry
process experts

*This is what really matters in the commercial laundry business:
higher performance, higher productivity, lower running costs
and maximum transparency in the laundry process.*

Electrolux Professional boasts first-rate expertise in laundry solutions, backed up by global leadership. We offer the largest solution and program flexibility on the market. **Our solutions provide significant time and money savings in the total process through 'Excellence inside' – intelligent features and unique extras:**

- ▶ Optimised water, energy and detergent consumption thanks to intelligent technology
- ▶ Faster cycle times
- ▶ Faster and more economic drying processes, due to lowest water retention
- ▶ Exact process monitoring by Certus Management™ Information System
- ▶ Best ironing performance on the market
- ▶ Greater service flexibility – experts, training and the world's largest service network



Electrolux Excellence

Excellence is central to everything we do. By anticipating our customers' needs, we strive for Excellence with our people, innovations, solutions and services. Thus making our customers' work and life easier and more profitable.



Unique Service Excellence

Always near.
Always there for you

A reliable, global presence: Electrolux Professional offers the most extensive service network of skilled, authorized partners for daily tasks: installation, spare parts and maintenance. All of them provide an efficient customer service and fast technical assistance. A global service network for prompt, expert advice worldwide.

- ▶ 1,900 authorised service centres
- ▶ Over 7,000 expert technicians
- ▶ 44,000 available spare parts in stock
- ▶ Spare parts are guaranteed for at least 10 years from the end of production
- ▶ 24–48 hr spare parts delivery worldwide

Electrolux

Excellence for your Commercial Laundry

Intelligent features and unique extras



Easy download of programs with Laundry Program Manager
▶ Create custom programs on your PC
▶ Transfer to machines via memory card (Clarus Control®) or USB cable (Compass Control® / Compass Pro®)



Total cost control with Certus Management™ Information System
Innovative software from Electrolux
▶ Boosts savings and profitability
▶ Enables process validation



Energy and water savings thanks to Integrated Saving System
▶ Optimal use of water
▶ Higher quality wash results



The best customising with Clarus Control®
▶ Fully programmable with up to 194 programs for optimal laundry



Maximum dewatering with Super Balance™ for faster drying
▶ Extra stability prevents unbalance
▶ Less maintenance costs and longer lifetime



Time savings in finishing with Reversing Drum Action
▶ Prevents tangling and reduces creasing of large items



Highest productivity thanks to Residual Moisture Control
▶ Measures the exact moisture content throughout the whole process



Time optimisation with Drum Speed Control
▶ Reduces energy consumption
▶ Controls free fall of garments in air flow



30% more output with Dubixium™ multilayer cylinder
Patented by Electrolux
▶ Efficiency of steam
▶ Guaranteed maximum profitability

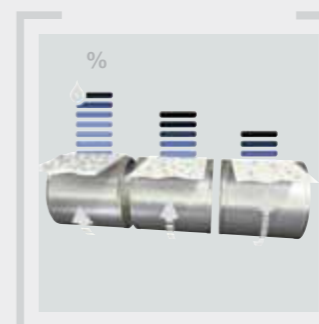

Always excellent quality and increased productivity with Direct Ironer Advanced Moisture Management System
Unique and patented by Electrolux



Excellent user-friendliness thanks to Smart Interface for IC series
▶ Ensures full control over the process and consistent quality



Configured for your requirements

Choose your
solution package

Specific requirements in terms of speed, performance and cost are our benchmark for configuring customised solutions. Washer, dryer, ironer – all Electrolux Professional Solutions complement each other perfectly. Choose the most profitable solution package for your business from the following!

Superior solution

Washer W41100H, Dryer T41200
C-Flex IL Feeder, C-Flex Ironer, C-Flex IL Flat Folder

Washer W41100H

- ▶ **Excellent washing, excellent care**
thanks to the Integrated Saving System for optimal loading of washer and efficient water and detergent dosing
- ▶ **Extra savings in drying**
by highest possible dewatering and SuperBalance™ Technology
- ▶ **The best customising**
thanks to the Clarus Control® microprocessor: fully programmable and can be tailored to your wash processes
- ▶ **More laundry cycles per day:**
time savings through lean cycles and fast operation (e.g. extra large doors for fast and easy loading/unloading)

Dryer T41200

Traditional or sliding door versions. Choose operation Excellence!

- ▶ **Best performance, high productivity:**
up to 10% faster and 15% more energy efficient
- ▶ **Low maintenance costs, fast servicing:** self-cleaning lint screen, easy access to vital parts
- ▶ **Extra flexible and efficient process**
by Reversing Drum Action and Drum Speed Control: fast and high quality drying
- ▶ **Energy and time savings:**
Autostop for when load is fully dry, plus Residual Moisture Control, the ultimate moisture sensing technology – **Unique from Electrolux**
- ▶ **More performance, less space (depth)**

C-Flex: heavy-duty flat work ironer

Unique from Electrolux

- ▶ **Chest type industrial ironer with mobile Super Flexible Chest and fixed roll,**
allowing for constant pressure and a maximum ironing surface for the utmost ironing quality
- ▶ **Unique fixed-cylinder and floating-chest concept**
for the best performance on the market

Advanced solution

Washer W4400H, Dryer T4900, Ironer IC44832 FFS

Washer W4400H

- ▶ **Excellent washing, excellent care** thanks to the Integrated Saving System for optimal loading of washer
- ▶ **Extra savings in drying** by highest possible dewatering and SuperBalance™ Technology
- ▶ **The best customising** thanks to the Clarus Control® microprocessor: fully programmable and can be tailored to your wash processes
- ▶ **Extra efficient on time, energy and operation:** direct steam for faster heating, extra large doors for fast and easy loading/unloading

Dryer T4900



Traditional or sliding door versions. Choose operation Excellence!

- ▶ **Best performance, high productivity:** up to 10% faster and 15% more energy efficient
- ▶ **Low maintenance costs, fast servicing:** self-cleaning lint screen, easy access to vital parts
- ▶ **Extra flexible and efficient process** by Reversing Drum Action and Drum Speed Control: fast and high quality drying
- ▶ **Energy and time savings:** Autostop when load is fully dry and Residual Moisture Control the ultimate moisture sensing technology – **Unique from Electrolux**
- ▶ **More performance, less space (depth)**

Ironer IC44832 FFS

- ▶ **Increased productivity and optimum hygiene:** Direct Ironer Advanced Moisture Management System – **Unique and patented by Electrolux**
- ▶ **Excellent quality:** special care options for plain and smooth linen
- ▶ **Safe and secure:** special devices for security and protection
- ▶ **Low maintenance costs:** Nomex® ironing belts designed for extended use at high temperatures
- ▶ **Time-efficient, cost-efficient:** single-person operation through the whole process, from feeding in wet items to receiving neat piles of folded, ironed sheets – the ultimate in ironing
- ▶ **Even more profitability** thanks to our many 'Excellence inside' features

Access solution

Washer W4240, Dryer T5550, Ironer IC43320

Washer W4240

- ▶ **Extremely low water and energy consumption**
- ▶ **Up to 50% water savings for half loads**
- ▶ **Extra savings in drying** by highest possible dewatering (high g-force 350 G) and SuperBalance™ Technology
- ▶ **Choose your Excellence software program:**
 - **The best utility cost optimisation: Compass Pro®** program package with intuitive interface and customised programs for tailored cleaning
 - **The best customising** thanks to the Clarus Control® microprocessor: fully programmable and can be tailored to your wash processes

Dryer T5550

- ▶ **Best performance, high productivity:**
 - 30% less drying time
 - 20% less energy consumption
 - 20% more drying capacity on the same wall space
- ▶ **Low maintenance costs, easy operation:** ergonomic lint screen, easy access to vital parts
- ▶ **Compass Pro® interface for easy program selection** with integrated service program for easy maintenance
- ▶ **Even more profitability** by numerous options for 'Excellence inside' (Reversing Drum Action, Residual Moisture Control, Heat Exchanger, Fresh Air Intake etc.)

Ironer IC43320

- ▶ **Gas savings of up to 20% and minimum downtime** with the Ceramic Gas Burner – **Unique and patented by Electrolux**
- ▶ **Excellent quality:** particular care features for plane and smooth linen
- ▶ **Safe and secure:** special devices for ergonomic and protection
- ▶ **Low maintenance costs:** Nomex® ironing belts designed for extended use at high temperatures stainless steel cylinder
- ▶ **Time, cost and quality efficient:** foldable feeding tray for large flats, return feed to save space
- ▶ **Even more profitability** thanks to our many 'Excellence inside' features (such as Direct Ironer Advanced Moisture Management System, Certus Management™ Information System, feeding and folding equipment)



Clarus Control® ensures the best customising



- ▶ Fully programmable with up to 194 programs for unparalleled versatility
- ▶ Create new programs directly on Clarus Control® panel or on your PC with Laundry Program Manager, then transfer them to machines via memory card
- ▶ Intelligent parameters save time, energy and water while delivering excellent wash and rinse results in every application
- ▶ 8 liquid detergent signals, plus efficient detergent dosing via connection to Efficient Dosing System
- ▶ Process monitoring via Certus Management™ Information System

Compass Pro® ensures the best utility cost optimisation



- ▶ Flexible and customisable
- ▶ Up to 55 programs available (15 own made)
- ▶ Large, clear display in 18 languages, plus integrated timer
- ▶ Process monitoring via Certus Management™ Information System

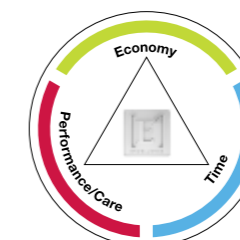

Unique Triangle Technology

The best flexibility and process performance

- ▶ **Economy:** optimum cost-effectiveness due to low energy consumption
- ▶ **Time:** the highest output due to short process times
- ▶ **Performance/Care:** the best cleaning/drying results

Technological Excellence makes the difference

Washer



Cost savings

- thanks to Water Reuse (optional)
- ▶ Water savings by reuse tank system



Long lifetime

- thanks to Heavy-duty Construction
- ▶ Quality components



Best ergonomoy prevents occupational injuries

- ▶ Tilting forward and backward
- ▶ Fast load and unload of big volumes



Faster wash cycle

- with drum Speed Soak
- ▶ Shortens wash cycle times
- ▶ Speeds up soaking process

Dryer



Faster loading and unloading

- with large and ergonomic door
- ▶ Optimal sized door



Increased life cycle and silent operations

- with Support Rollers
- ▶ Improved drum stability



Trouble-free operations

- thanks to Sturdy Drum Suspension
- ▶ Double-sealed bearings and belt drive



Less maintenance

- with Advanced Blower Wheel
- ▶ Extended machine life

Ironer (e.g. C-Flex-series): heavy-duty flat work ironer

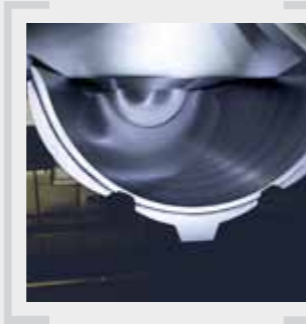

Energy savings

- thanks to Super Flexible Chest
- ▶ Improved ironing finish with max. output
- Unique fixed-cylinder and floating-chest**



Best-in-class drying capacity

- thanks to Performing Exhaust Technology
- ▶ Most efficient vapour exhaust
- ▶ Intelligent technique keeps bearings cold



Up to 20% gas savings

- with Ceramic Gas Burner
- ▶ Maximum productivity
- Unique and patented by Electrolux**



Best productivity > 92%

- with Extra-Efficient Boiler
- ▶ 30% energy savings
- ▶ Low operation cost.
- Work at atmospheric pressure



For tailor-made solutions
Contact us

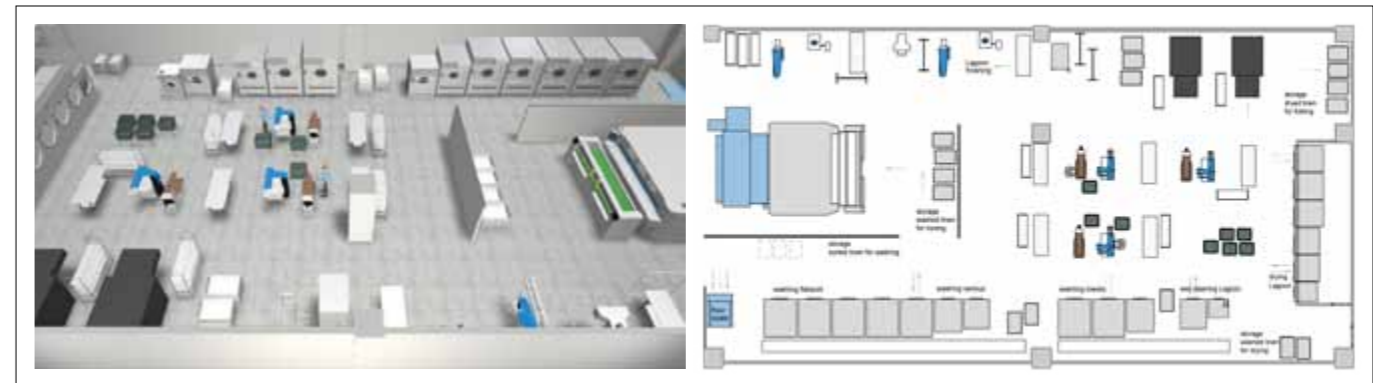

Flexible medium size commercial laundry (1,000 kg/h) serving small hotels, restaurants and old people homes

Tailor-made solutions

Whatever your business requires – any kind of commercial laundry, sheltered workshops, prisons, specialised clean room solutions – we design the most innovative and efficient solution to fit your needs.

With innovative planning tools, our laundry experts will simulate any kind of configuration and provide you with a virtual reality draft.

Consultative selling

We are your partner throughout the entire process.

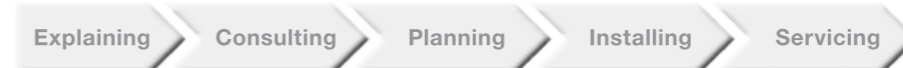



Thinking of you
Electrolux

Electrolux Professional

Commercial Laundry Solutions

Hygiene Laundry Solutions

In-House Laundry Solutions

Consumer-Operated Laundry Solutions



Excellence inside
and the environment in mind

Electrolux Professional solutions perfectly match the customers' needs, including the areas of reliability, cost efficiency and sustainability. The products are the best in terms of quality – durability with low running costs. Some installations have been running for more than 40 years!

- ▶ All Electrolux factories are ISO 14001-certified
- ▶ All Electrolux Professional products are designed for low water, energy and detergent consumption, and for low emissions into the environment
- ▶ All Electrolux Professional products are ROHS-compliant and over 95 % recyclable
- ▶ All units are quality tested, piece by piece, and all of the functions are singularly checked by expert technicians
- ▶ In the last five years, more than 70% of Electrolux Professional solutions have been updated with features that are always designed with the needs of customers and environmental considerations in mind

**Discover the Electrolux Excellence
and share more of our thinking at
www.electrolux.com/laundrysystems**

